



startIng!

Montagehilfe zum Austausch von
Propellerblättern auf See

Team Bertha Benz

Gliederung

- Hauptanforderungen
- Funktionsweise
- Auftriebskörper
- Kostenrechnung

Unsere Hauptanforderungen

- Platzsparend
- Schneller und einfacher Austausch
- Kostengünstig



Funktion am Modell

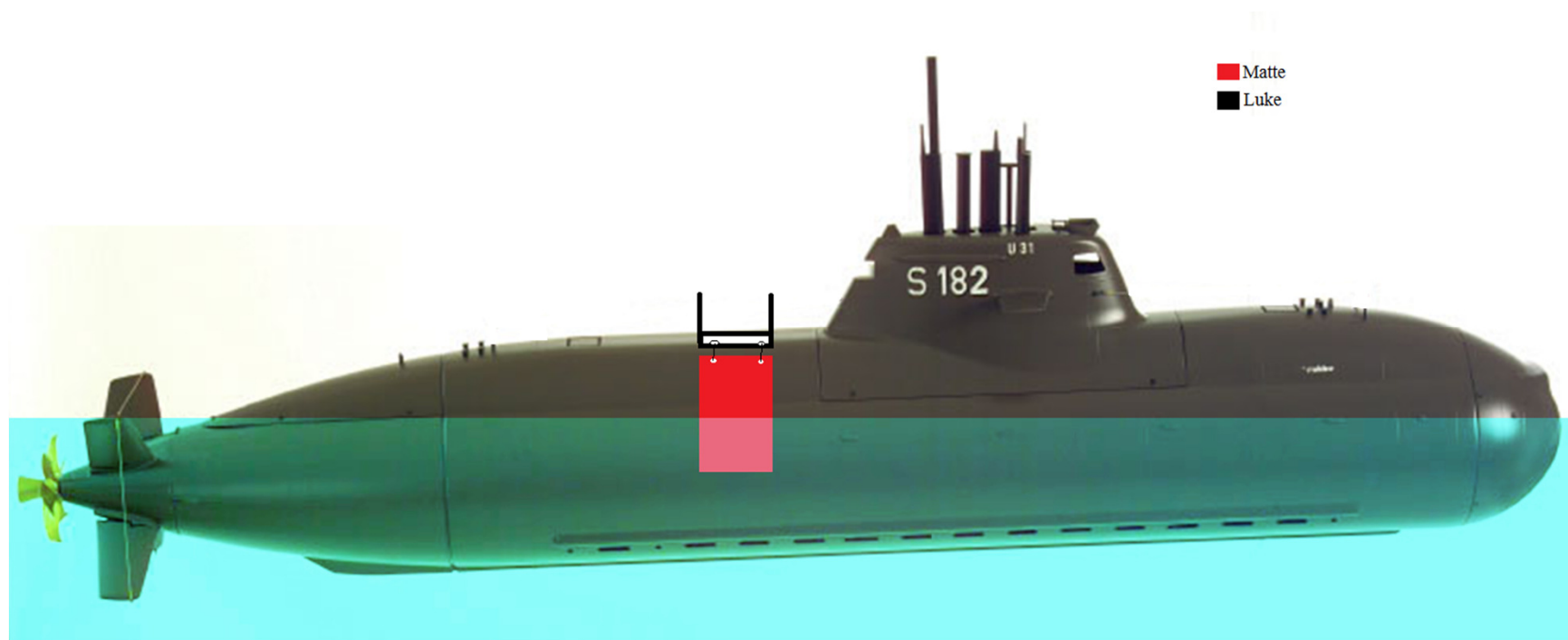

Funktion am Modell

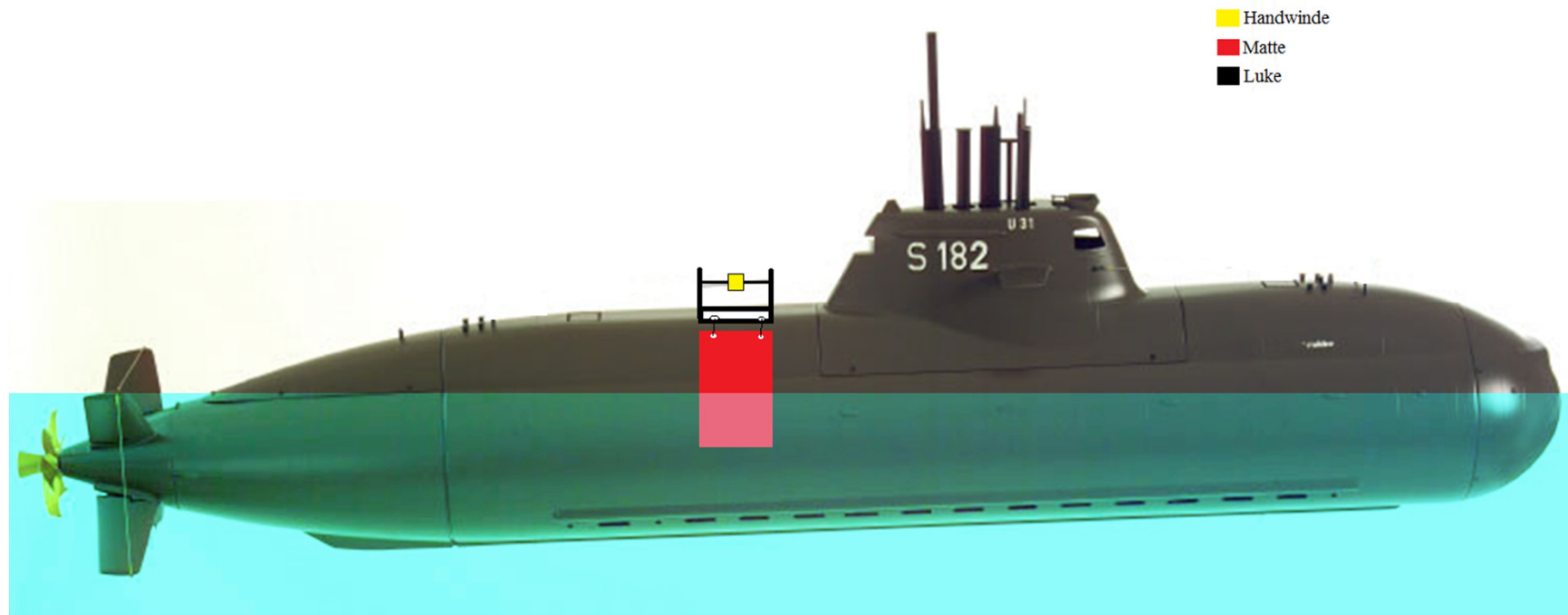

Funktion am Modell

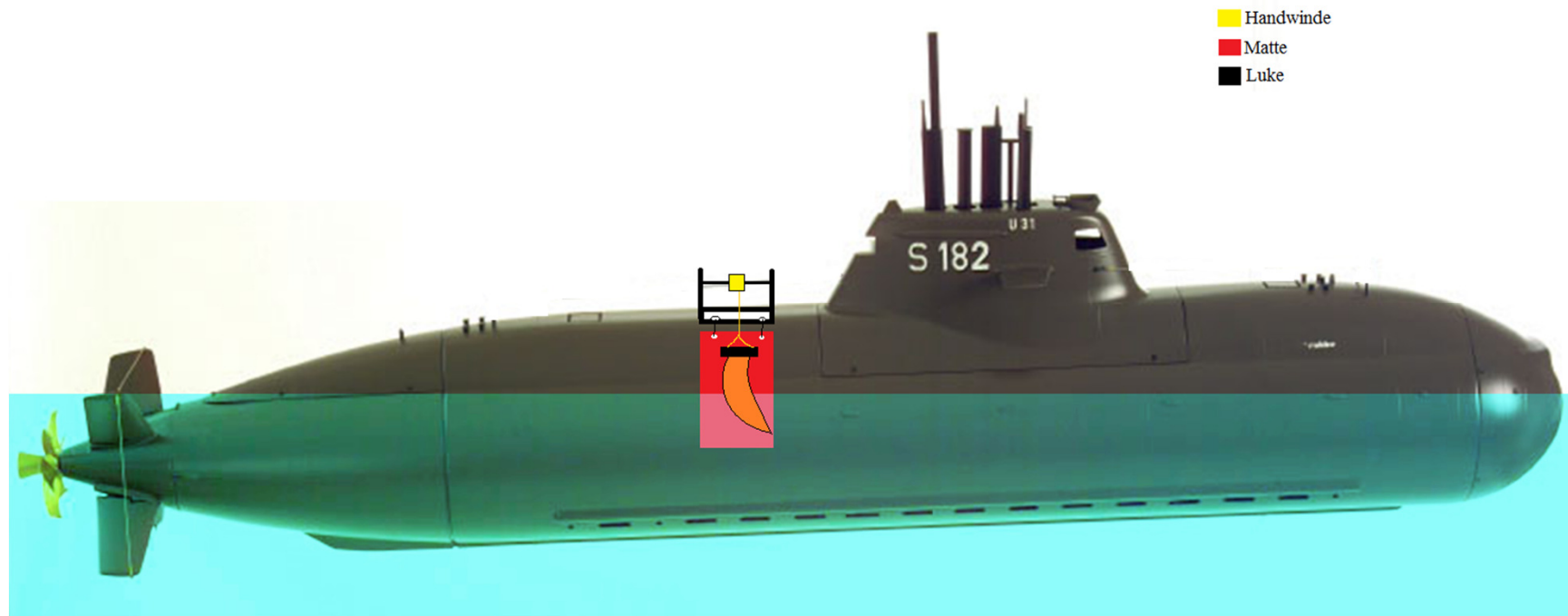

Funktion am Modell

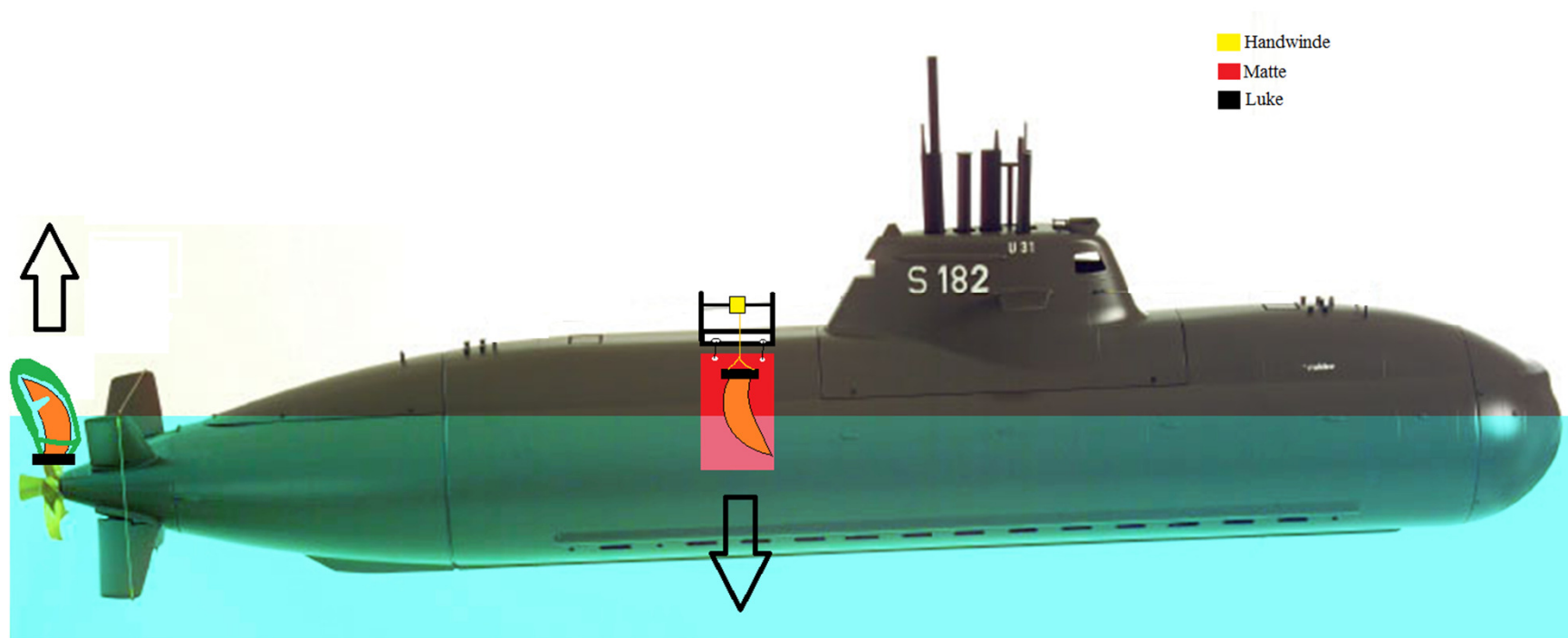

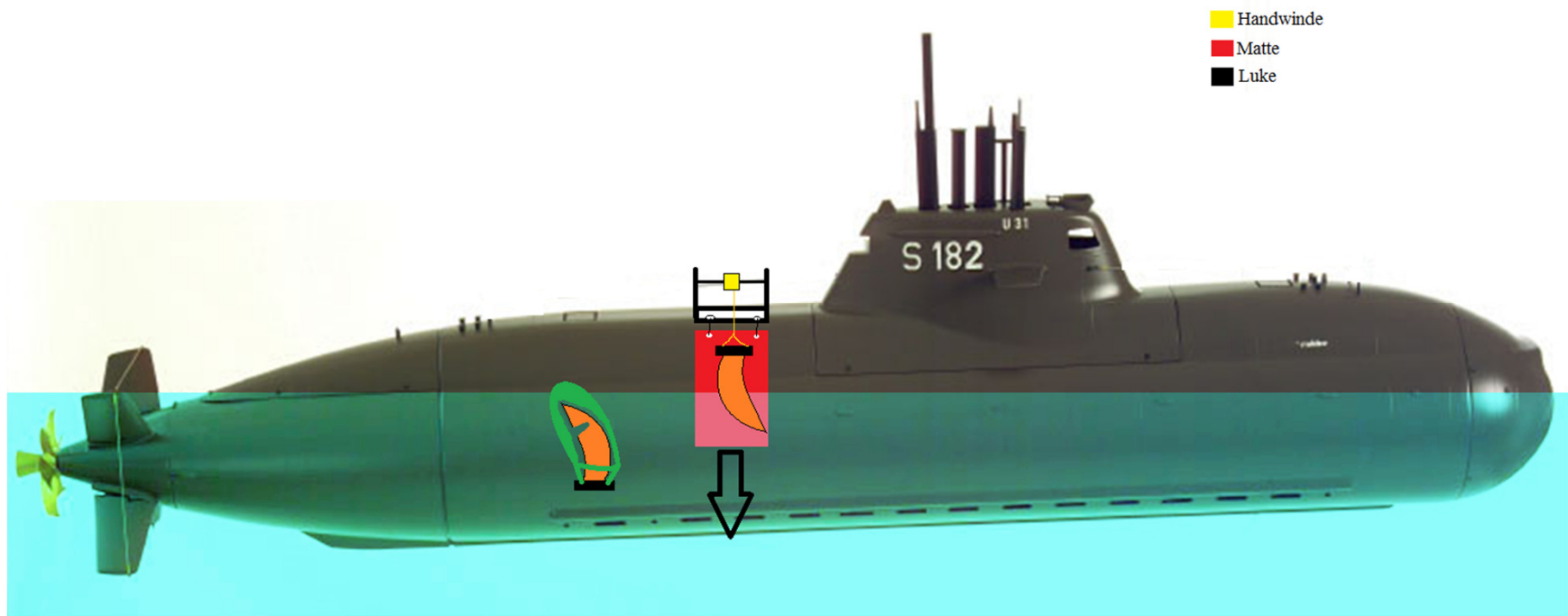

- Handwinde
- Matte
- Luke

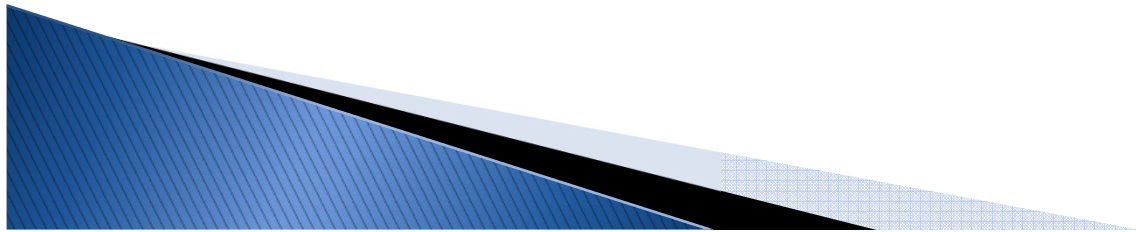

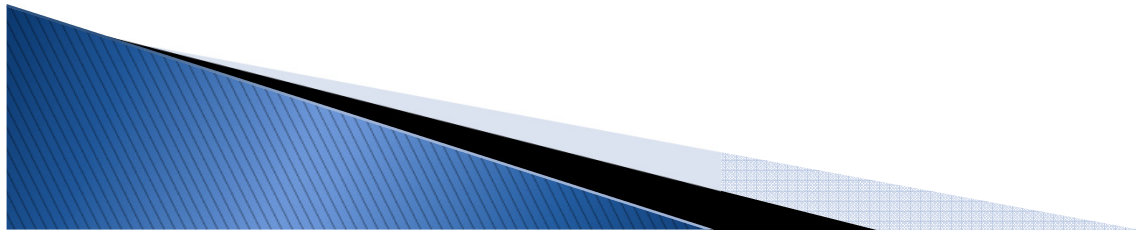
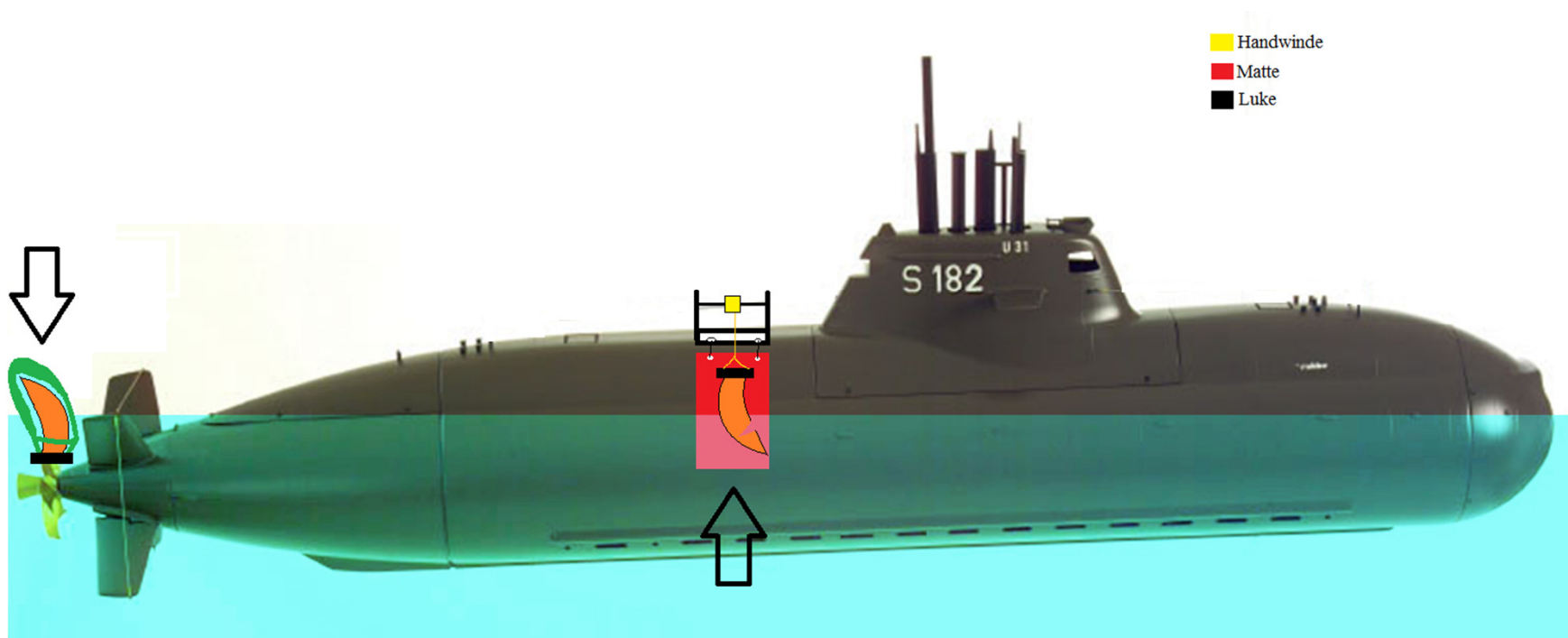

Funktionsweise

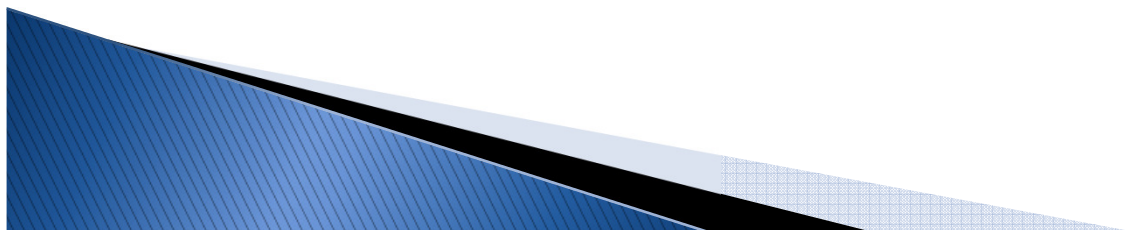
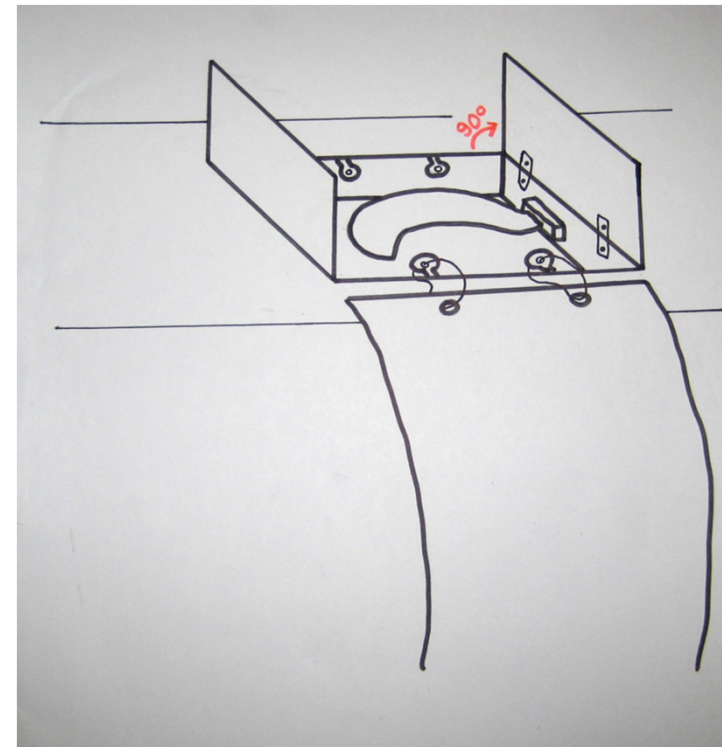
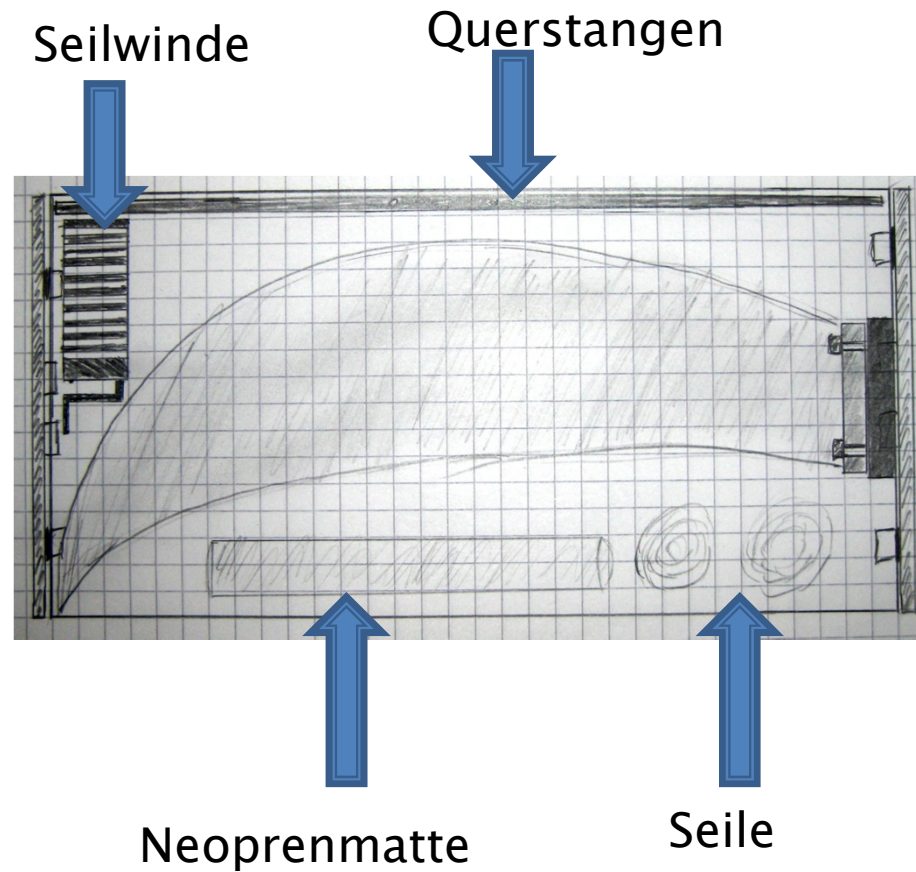

Funktionsweise

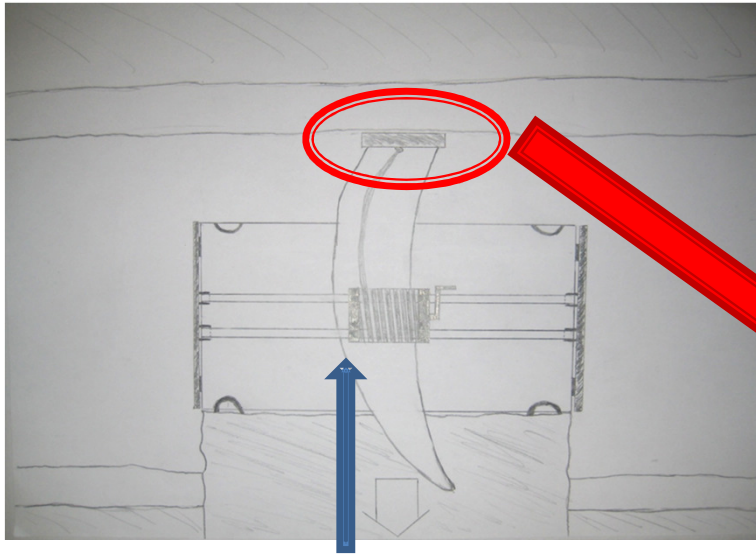

Seilwinde

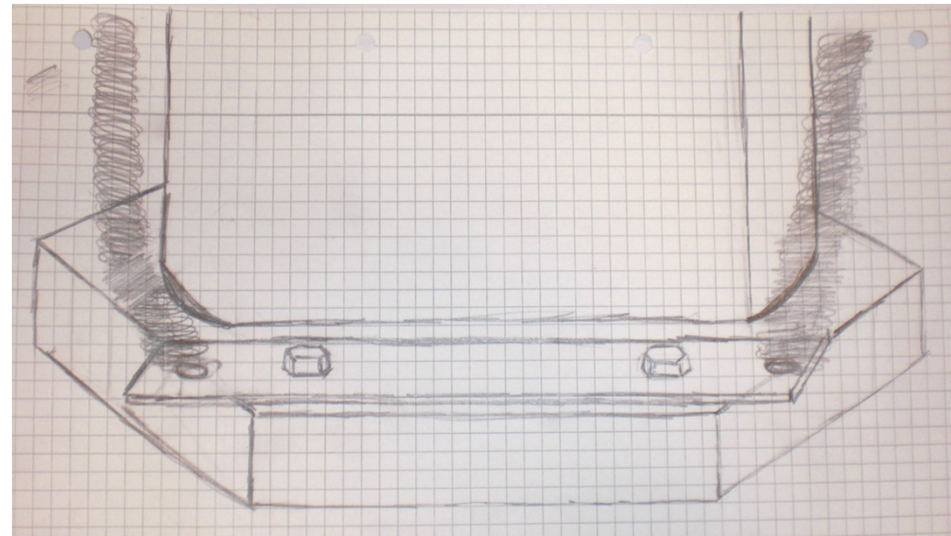

Funktionsweise

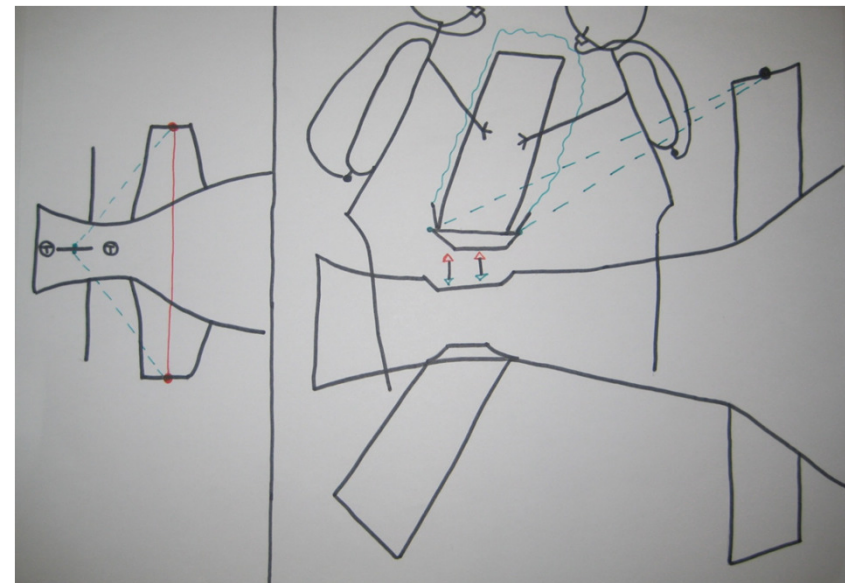
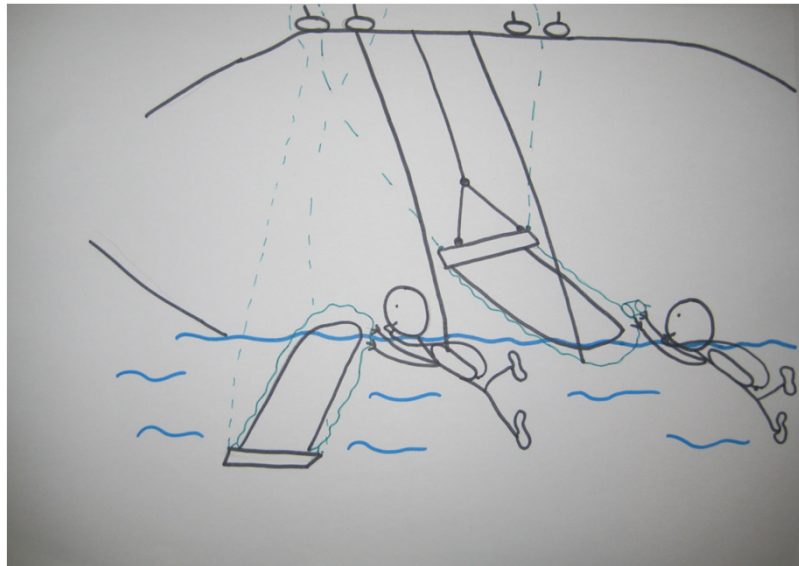

Auftriebskörper

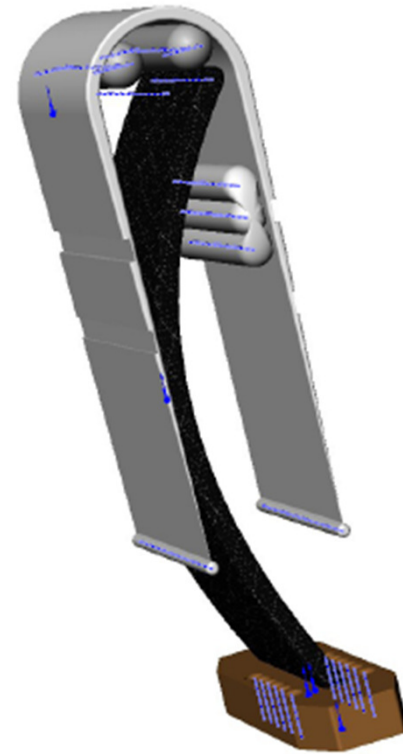
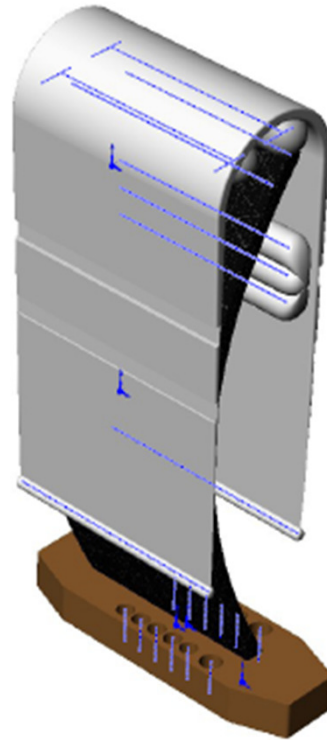

Auftriebskörper

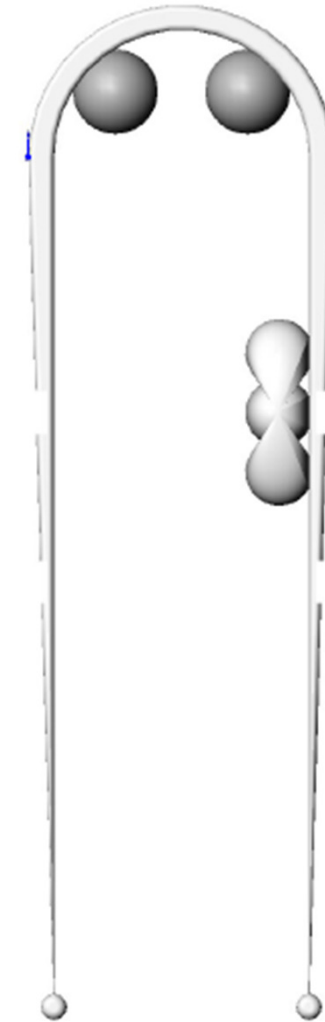
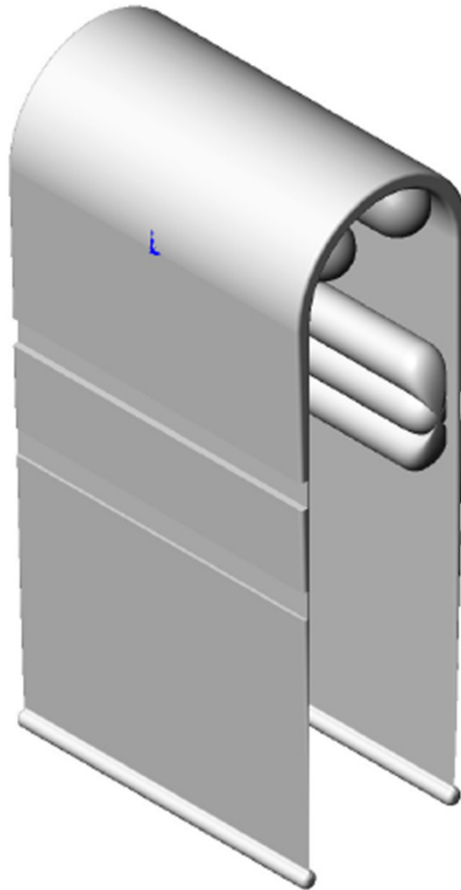
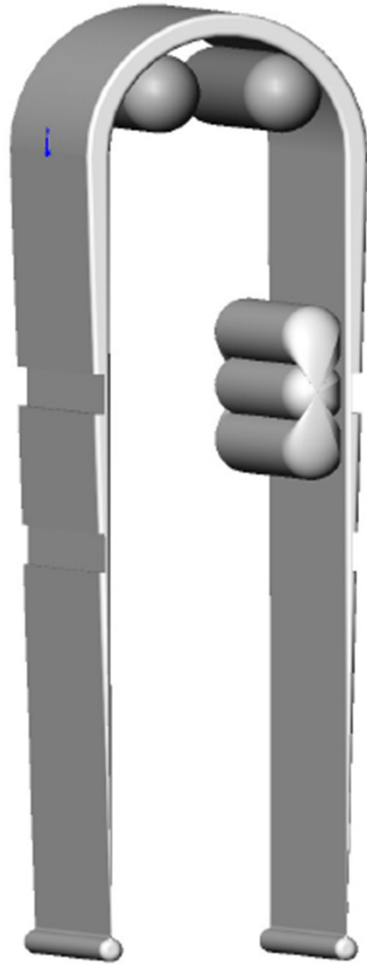

Kostenrechnung

1. Materialkosten:	6590€
2. Lohnkosten für Montage:	200€
3. Entwicklungskosten:	<u>50625€</u>

Gesamtkosten: 57415€

Fazit

- Platzsparend ✓
- Schneller und einfacher Austausch ✓
- Kostengünstig ✓

Vielen Dank für Ihre Aufmerksamkeit!

Team Bertha Benz 04.11.2010



FACHHOCHSCHULE KIEL
University of Applied Sciences